



**Plus+**

**easy**

**good**

**GRI FOLYO**  
Ambalaj Sanayi

• [www.grifolyo.com](http://www.grifolyo.com) •



TR

### ALÜMİNYUM FOLYO KAPLARIN ÖZELLİKLERİ

Tamamen inert (etkisiz) bir metal olan alüminyum içine konulan gıdalara ya da gıdalardan kendisine bir geçişe izin vermez. Bu yüzden gıdalarda herhangi bir koku, tat, renk kaybı ve değişikliği söz konusu değildir. Alüminyum kaplar ürünleri uzun süre tadı ve lezzeti bozulmadan muhafaza eder. Çabuk bozulan gıdaları bütün çevresel ve mevsimsel etkilerin olumsuzluklarından koruyabilir. Alüminyum kaplar hijyeniktir. Yüzeyinde bakteri ve diğer mikroorganizmaların üremesi için ortam oluşturmaz. Çok çeşitli sıcaklıklarda çatlamadan, erimeden, yanmadan ve kavrulmadan kullanılabilir. Isıyı muhafaza etme özelliği nedeniyle enerji tasarrufu sağlar; işleme, soğutma ve tekrar ısıtma sürelerini asgariye indirir. Emici olmayan özelliği sayesinde bakteri büyümesini engelleme veya nemin ve yağın emilmesini bertaraf eder. Gofrajlı kenarlar ve kabartmalı taban desenleri sayesinde kabın sertliğinin ve sağlamlığının artmasını sağlar. Isı, ışık, ses, nem ve gaz gibi faktörlere karşı kusursuz dayanıklıdır. Ele almada, açmada, kullanımda ve yok etmede kolaylık sağlar. Parlak ve yansıtıcı özelliğe sahiptir. Çeşitli dizaynlarda kapak çeşitleri kullanmayı mümkün kılar. Doğa dostu geri dönüşüm malzemesidir. Soğuk şekil verme (presleme) özelliği sayesinde %30 enerji tasarrufu sağlar.

### KULLANIM ALANLARI

Pişmiş gıdaların işlenmesi ve paketlenmesinde. Isıl işlenmiş sütlü tatlılar, pişirmeye hazır etler, donmuş tatlılar veya buna benzer uygulamalarda kullanılmaktadır.

EN

### FEATURES OF ALUMINUM FOIL TRAYS

Due to the characteristics of aluminum, it is especially useful for handling many sorts of foods, it is able to keep food from losing any type of smell, taste and colour therefore keeping the product safe and fresh to consume. Aluminum foil trays are also a great way to store food hygienically for consumers. Aluminum foil trays don't crack or deform in the instance of hot products being used in the process of packaging. Aluminum foil trays are completely water proof and do not absorb or leak which makes it ideal for handling food storage. Aluminum foil trays are designed and manufactured to be strong, stable and versatile. Able to withstand heat, light, noise, moisture and gasses. Easy to transport, open, package and dispose. Aluminum is a reflective product. Easy to design and make multiple sizes and designs. Can have energy benefits of 30% as it is a cold press product. Aluminum is a recyclable product therefore making it safe for our environment and surroundings.

### WHAT CAN YOU USE ALUMINUM TRAYS FOR

Aluminum foil trays can be used for all types of cooked, processed or raw foods. Being able to withstand heat, it is especially useful for packaging products such as meats, milk products, ice creams and desserts.

AR

### خصائص الأوعية الألومنيوية :

كون الألمنيوم معدن خامل ( غير مؤثر ) فهذا يمنحه خاصية عدم النفوذ إلى المواد الغذائية وكذلك فهو لا يسمح للمواد الغذائية بالنفوذ منه . لهذا السبب فإنه من البديهي أن لا نلاحظ في الأغذية أي تغير أو فقدان للرائحة والطعم أو اللون.

الأطباق المصنعة من الألمنيوم تحافظ على طعم ولذة المنتجات لفترة طويلة دون أن تخرب .

تقي الأغذية المعروفة بسرعة فسادها من كافة التأثيرات المناخية السلبية والمحيط بها .

الأطباق المصنعة من الألمنيوم معقمة ، لا تسمح بتشكيل وسط يساعد على نمو البكتيريا والجراثيم .

يمكن إستخدامها في درجات حرارة مختلفة دون أن تتعرض للتشقق أو الذوبان أو الإحتراق أو التفحم .

نظراً لخاصية الألمنيوم في الإحتفاظ بالحرارة فهو يعمل على توفير الطاقة . تعمل على تخفيض فترات التشغيل والتبريد ومن ثم التسخين إلى الحد الأدنى .

بسبب خاصية الألمنيوم من حيث عدم النفوذية الأمر الذي يساعد على منع تكاثر البكتريا وكذلك على منع إمتصاص الرطوبة والمواد الدهنية.

الحواف المعكوفة والأشكال النافرة لقاعدة الأطباق الألومنيوية تعمل على زيادة متانتها وقساوتها .

مقاومة متالية لمؤثرات الحرارة والضوء والصوت والرطوبة والغازات .

سهولة في الإلتقاط والفتح والإستخدام وحتى في سهولة التخلص منها .

تمتاز الأطباق بخاصية اللعان والإنعكاس .

تسمح بإستخدام أنواع مختلفة من الأعطية ذات التصاميم المختلفة .

تعد المواد المصنعة من الألمنيوم صديقة للبيئة نظراً لسهولة إعادة تشكيلها .

بسبب خاصية تشكيلها على البارد (بطريقة الكبس) فإن هذا يؤدي إلى وفر 30% من الطاقة .

### مجالات الإستخدام :

في صنع الأغذية المطهية وتغليفها .  
في الحلويات المصنعة من الحليب حرارياً ، في اللحوم الجاهزة للطهي، في الحلويات المجمدة أو مايشابهها من المنتجات الأخرى

## ALUMİNYUM FOLYO KAPLAR / ALUMINIUM FOIL CONTAINERS





Sütlaç Kase  
Sweet Tray

صحن رز بحليب - مهلبية



GS-300

### BOYUTLAR / DIMENSION





	108X108 mm
	97x97 mm
	74x74 mm
	40 mm
	300 cc

## G-250L



G-250L

### BOYUTLAR / DIMENSION





	146x120 mm
	130x104 mm
	112x87 mm
	27 mm
	310 cc

## G-350L



G-350L

### BOYUTLAR / DIMENSION

	146x121 mm
	129x104 mm
	109x84 mm
	40 mm
	430 cc

ALUMİNYUM FOLYO KAPLAR / ALUMINIUM FOIL CONTAINERS

**G-500L**



BOYUTLAR / DIMENSION

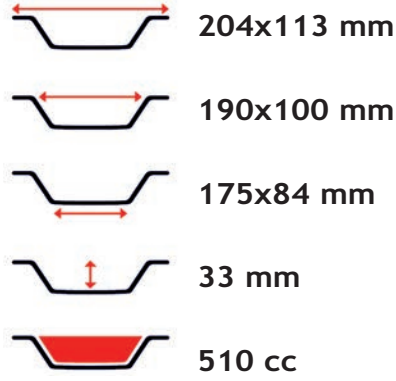

**G-750L**



BOYUTLAR / DIMENSION

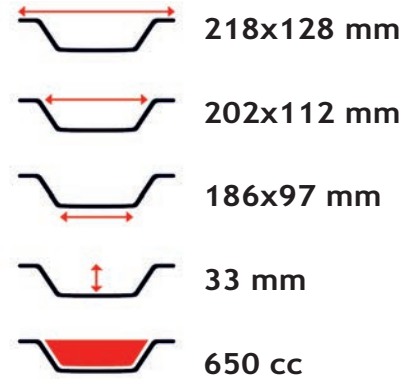

**G-1000L**



BOYUTLAR / DIMENSION

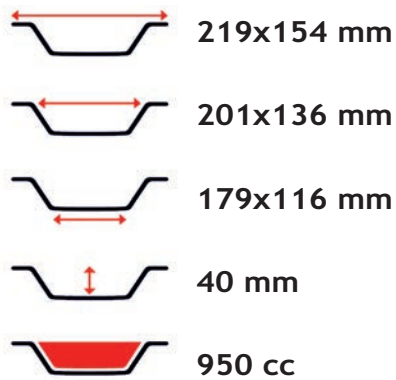





ALUMİNYUM FOLYO KAPLAR / ALUMINIUM FOIL CONTAINERS

**G-1500L**

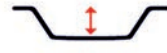

BOYUTLAR / DIMENSION

	226x175 mm
	208x157 mm
	195x143 mm
	35 mm
	1125 cc





Küçük Boy Tepsi

Small Tray

صينية صغيرة



BOYUTLAR / DIMENSION

	319X226 mm
	295X198 mm
	271X171 mm
	44 mm
	2380 cc





Orta Boy Tepsi

Medium Tray

صينية وسط



BOYUTLAR / DIMENSION

	321X262 mm
	298x238 mm
	271x211 mm
	55 mm
	3250 cc

## Büyük Boy Tepsi

### Large Tray

### صينية كبيرة



#### BOYUTLAR / DIMENSION

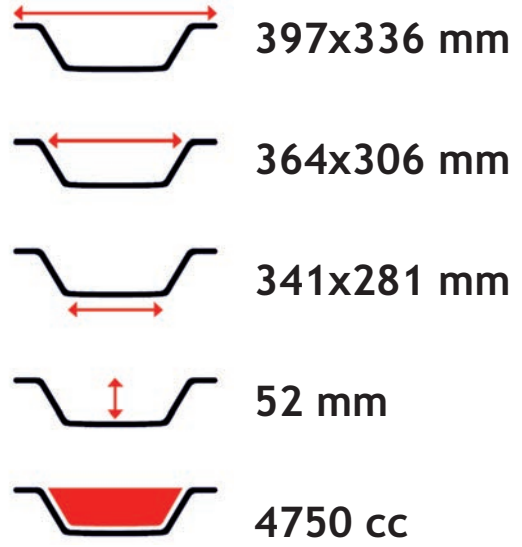

## Jumbo Tepsi

### Jumbo Tray

### صينية حجم كبير



#### BOYUTLAR / DIMENSION

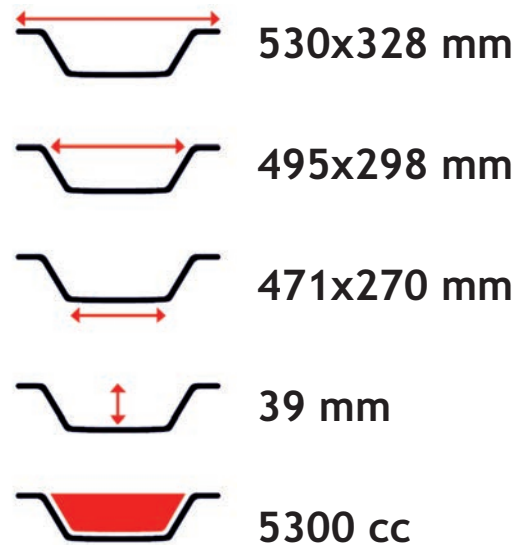



ALUMİNYUM FOLYO KAPLAR / ALUMINIUM FOIL CONTAINERS

**Metalize Karton Kapak**  
**Metallized - Laminated Cardboard Lids**



**BOYUTLAR / DIMENSION**

**K2535 - 140x115 mm**

**K500 - 201x109 mm**

**K750 - 213x122 mm**

**K1000 - 211x150 mm**

**K1500 - 220x168 mm**

**K2380 - 307x207 mm**

**K3250 - 315x255 mm**

**Aluminyum Folyo**  
**Aluminium Foil**  
**ألومينيوم فوليو**



**Genişlik / Width: 29-30 or 44-45**

**Micron: 10 - 18**





www.aksoymatbaa.com

+90 532 248 22 00

Sanayi Mah. 60348. Sk. No:13 (Halıcılar Sanayi Sitesi) Şehitkamil / GAZİANTEP

www.grifolyo.com • info@grifolyo.com • grifolyo@gmail.com